

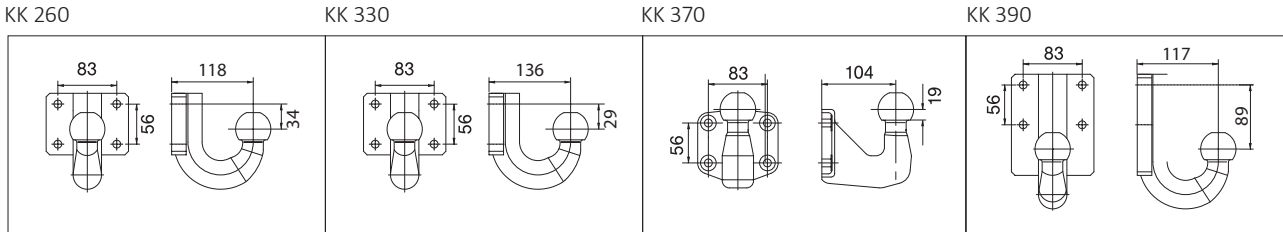

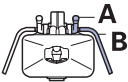

50 mm – Kugel • ball • boule • sfera • bola

- DE** Kugelkupplungssystem mit Flansch
- EN** Ball hitch with flange
- FR** Attelage à boule avec platine
- IT** Gancio a sfera con flangia
- ES** Enganches esféricos con brida



Technische Daten • Technical data • Données technique • Dati tecnici • Datos técnicos



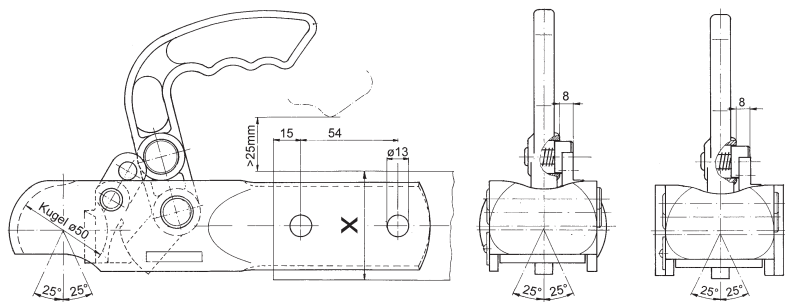
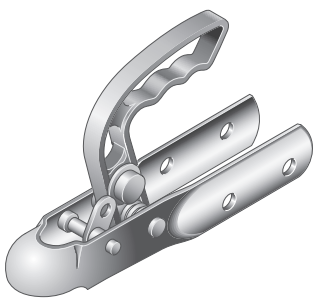

	 (mm)	 D (kN)	 S (kg)	ECE
RO KK260	83 x 56	22,5	275	E4 55R-01 0101
RO KK330	83 x 56	19,0	200	E4 55R-01 0101
RO KK370	83 x 56	27,5	300	E4 55R-01 0100
RO KK390	83 x 56	22,1	270	E4 55R-01 0099

RO★200

- DE** Zugkugelkupplung zur Verbindung mit Kupplungskugel 50 mm
- EN** Ball hitch for connecting with coupling ball 50 mm
- FR** Attelage à boule d'assemblage avec une boule d'attelage 50 mm
- IT** Gancio a sfera in combinato con un gancio a sfera 50 mm
- ES** Enganches esféricos para la conexión con una cabeza 50 mm



Technische Daten • Technical data • Données technique • Dati tecnici • Datos técnicos

	Typ	Deichsel • Drawbar • Flèches • Forcelle • Barras • (mm)	 S (kg)	 C (kg)	 ø (mm)	 (kg)	ABG KTA
RO 200A0050	KK 92 A	ø 70	120	1600	50	1,4	1708
RO 200B0050	KK 92 B	ø 60	120	1600	50	1,4	1708
RO 200F0050	KK 92 F	ø 60	120	1600	50	1,4	1708