

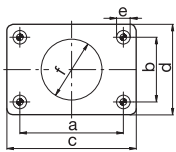

RO*57 flex – 57 mm

- DE** Anhängerkupplung für hohe Beanspruchungen und im Off-Road-Einsatz
- EN** Towing hitch for rugged conditions and off road applications
- FR** Crochet d'attelage pour sollicitations élevées et en utilisation off-road
- IT** Gancio di traino per elevate sollecitazioni e fuoristrada
- ES** Enganche para remolque para altas prestaciones fuera de la carretera

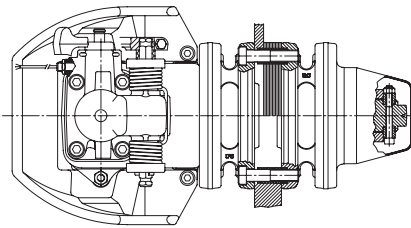

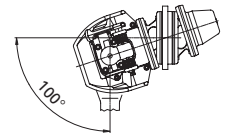
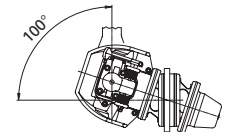
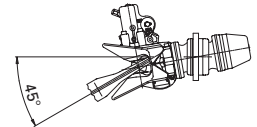
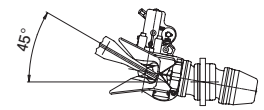
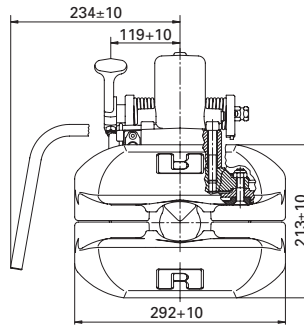
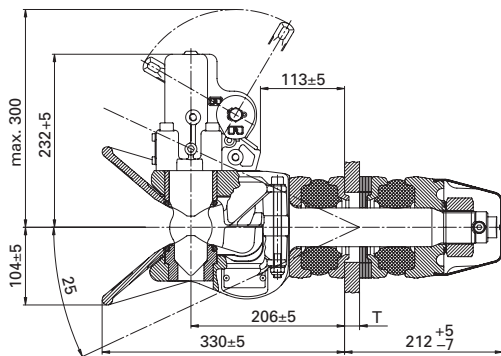

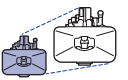
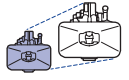



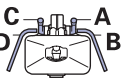
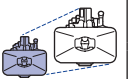

a = 57,5 mm
 Schwedische Norm
 Swedish standard
 Norme suédoise
 Normativa svedese
 Norma sueca

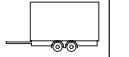

	a (mm)	b (mm)	c (mm)	d (mm)	e (mm)	f (mm)		T (mm)		T (mm)
6	160,0	100,0	200,0	140,0	21,0	94,0	6	-		max. 35



Technische Daten • Technical data • Données technique • Dati tecnici • Datos técnicos

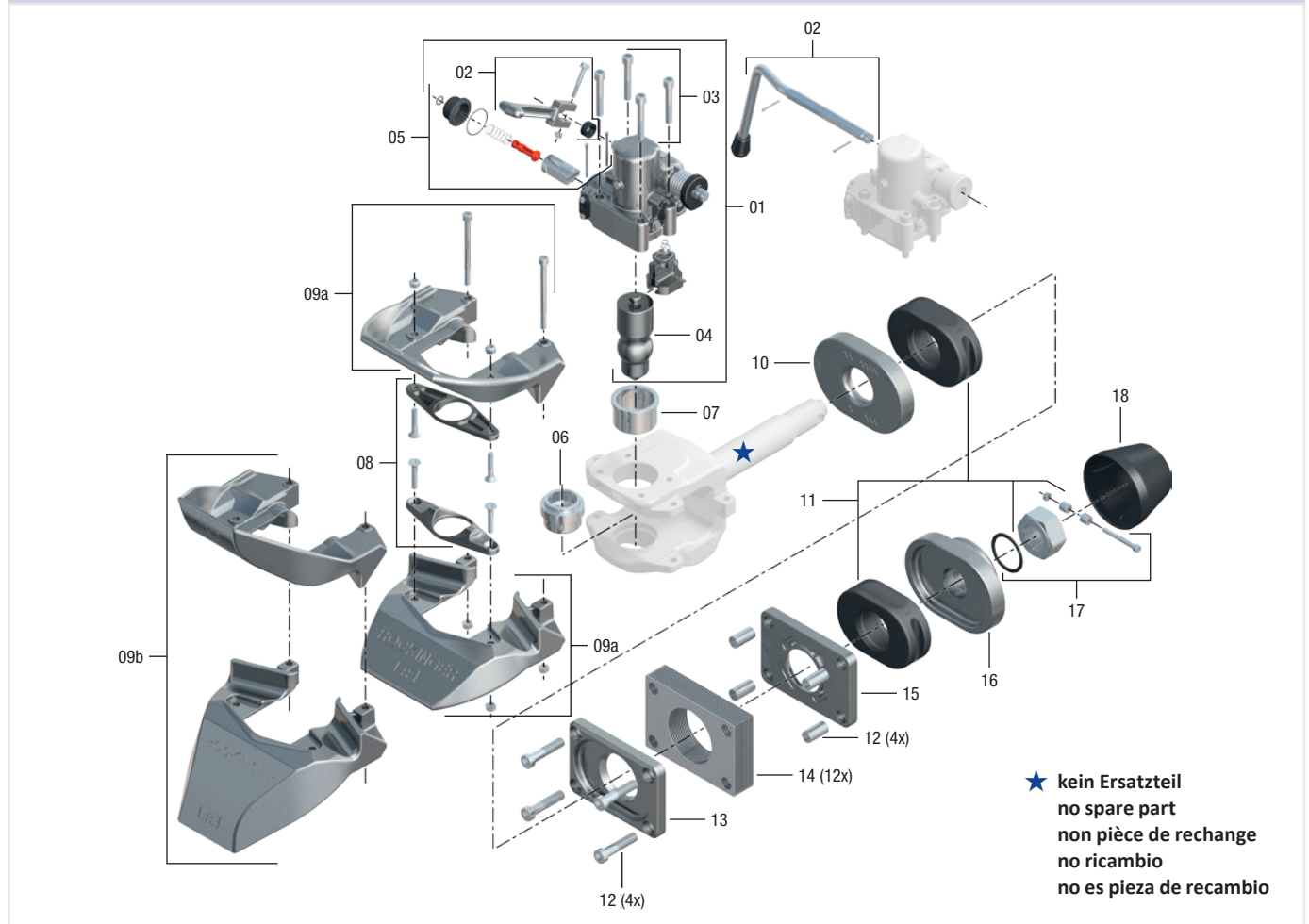

		 (mm)	 D (kN)	 Dc (kN)	 S (kg)	 V (kN)	 (kg)	ECE			 b a
RO 576 C 61000	6	160 x 100	260				57	E1 55R-01 2535			
RO 576 D 61000	6	160 x 100	260				57	E1 55R-01 2535			
RO 576 C 61400	6	160 x 100	260				63	E1 55R-01 2535	x	x	
RO 576 C 61560	6	160 x 100	260				65	E1 55R-01 2535	x	x	a

RO★57 flex

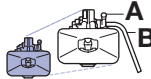
Ersatzteile • Spare parts • Pièces de rechange • Ricambi • Piezas de recambio

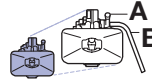

Pos		ROE	
01	RO 576Cxxxx	ROE 71192	1
01	RO 576Dxxxx	ROE 71818D	1
02	RO xxxCxxxx	ROE 50257	1
02	RO xxxDxxxx	ROE 50302	1
03		ROE 30229	1
04		ROE 47116	1
05		ROE 71153	1
06		ROE 53544	1
07		ROE 53543	1
08		ROE 71154	2
09a		ROE 71161	2
09b		ROE 71162	2

Pos		ROE	
10		ROE 12615	1
11		ROE 71266	1
12		ROE 30399	1
13		ROE 43478	1
14		ROE 15690	12
15		ROE 43479	1
16		ROE 43480	1
17		ROE 56122	1
18		ROE 25347	1

Reparatursatz • Repair kit • Kit de réparation • Kit riparazione • Juego de reparation

Pos	ROE
04, 06, 07, 08	ROE 71675